

Article number: 201241459

Description: E+G Retaining magnets with threaded stud GN 52.4-AN-40-M8-E
Alu, Nickel, Cobalt - 450° C, 240N

Measures

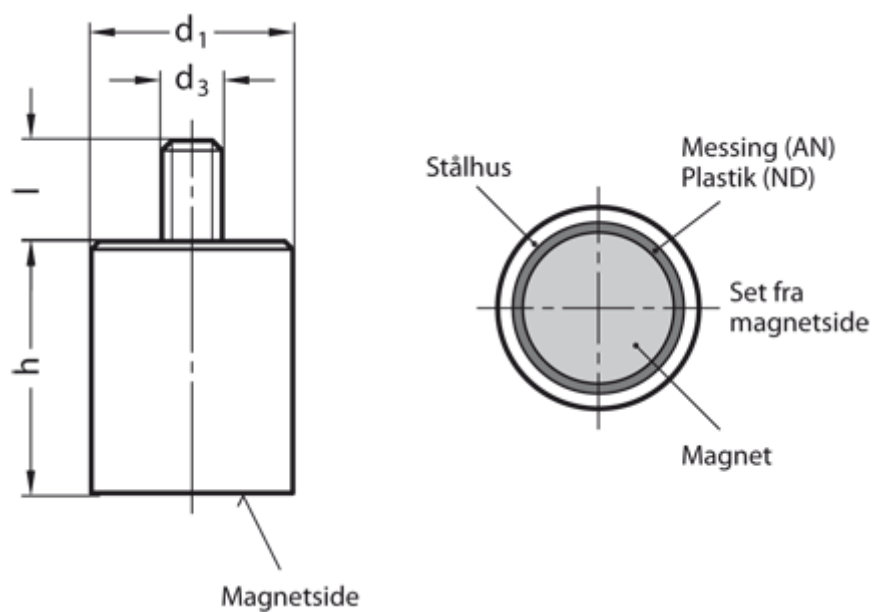

d1	= 40
d3	= M8
h	= 50 ±0,2
Holding force N	= 240.0
l	= 15
Material	= AN Alu, nickel, cobalt, 450°C